

# Online UPS

EN



- PowerWalker VFI 10000CP 3/3
- PowerWalker VFI 15000CP 3/3
- PowerWalker VFI 20000CP 3/3
- PowerWalker VFI 30000CP 3/3

## Manual

EN

**Uninterruptible Power Supply System**





**Please comply with all warnings and operating instructions in this manual strictly. Save this manual properly and read carefully the following instructions before installing the unit. Do not operate this unit before reading through all safety information and operating instructions carefully.**





# Table of Contents

<b>1. SAFETY AND EMC INSTRUCTIONS .....</b>	<b>1</b>
1-1. TRANSPORTATION AND STORAGE .....	1
1-2. PREPARATION .....	1
1-3. INSTALLATION .....	1
1-4. OPERATION .....	2
1-5. STANDARDS.....	2
<b>2. INSTALLATION AND OPERATION .....</b>	<b>3</b>
2-1. UNPACKING AND INSPECTION .....	3
2-2. REAR PANEL VIEW.....	4
2-3. SINGLE UPS INSTALLATION.....	5
2-4. UPS INSTALLATION FOR PARALLEL SYSTEM.....	8
2-5. SOFTWARE INSTALLATION.....	9
<b>3. OPERATIONS.....</b>	<b>10</b>
3-1. BUTTON OPERATION .....	10
3-2. LED INDICATORS AND LCD PANEL.....	10
3-3. AUDIBLE ALARM .....	12
3-4. SINGLE UPS OPERATION.....	12
3-5. PARALLEL OPERATION .....	15
3-6. ABBREVIATION MEANING IN LCD DISPLAY .....	16
3-7. LCD SETTING .....	17
3-8. OPERATING MODE/STATUS DESCRIPTION .....	23
3-9. FAULT CODE.....	29
3-10.WARNING INDICATOR .....	29
3-11.WARNING CODE .....	30
<b>4. TROUBLE SHOOTING .....</b>	<b>30</b>
<b>5. STORAGE AND MAINTENANCE.....</b>	<b>32</b>
5-1. STORAGE.....	32
5-2. MAINTENANCE.....	32
<b>6. SPECIFICATIONS .....</b>	<b>33</b>

## 1. Safety and EMC instructions

Please read carefully the following user manual and the safety instructions before installing the unit or using the unit!

### 1-1. Transportation and Storage



Please transport the UPS system only in the original package to protect against shock and impact.



The UPS must be stored in the room where it is ventilated and dry.

### 1-2. Preparation



Condensation may occur if the UPS system is moved directly from cold to warm environment. The UPS system must be absolutely dry before being installed. Please allow at least two hours for the UPS system to acclimate the environment.



Do not install the UPS system near water or in moist environments.



Do not install the UPS system where it would be exposed to direct sunlight or nearby heater.



Do not block ventilation holes in the UPS housing.

### 1-3. Installation



Do not connect appliances or devices which would overload the UPS (e.g. big motor-type equipment)) to the UPS output sockets or terminal.



Place cables in such a way that no one can step on or trip over them.



Do not block air vents in the housing of UPS. The UPS must be installed in a location with good ventilation. Ensure enough space on each side for ventilation.



UPS has provided earthed terminal, in the final installed system configuration, equipotential earth bonding to the external UPS battery cabinets.



The UPS can be installed only by qualified maintenance personnel.



An appropriate disconnect device as short-circuit backup protection should be provided in the building wiring installation.



An integral single emergency switching device which prevents further supply to the load by the UPS in any mode of operation should be provided in the building wiring installation.



Connect the earth before connecting to the building wiring terminal.



Installation and Wiring must be performed in accordance with the local electrical laws and regulations.

## 1-4. Operation



Do not disconnect the earth conductor cable on the UPS or the building wiring terminals in any time since this would cancel the protective earth of the UPS system and of all connected loads.



The UPS system features its own, internal current source (batteries). The UPS output sockets or output terminal blocks may be electrically live even if the UPS system is not connected to the building wiring outlet.



In order to fully disconnect the UPS system, first press the "OFF" button and then disconnect the mains.



Ensure that no liquid or other foreign objects can enter into the UPS system.



The UPS can be operated by any individuals with no previous experience.

## 1-5. Standards

<b>* Safety</b>	
IEC/EN 62040-1	
<b>* EMI</b>	
Conducted Emission.....:IEC/EN 62040-2	Category C3
Radiated Emission.....:IEC/EN 62040-2	Category C3
<b>*EMS</b>	
ESD.....:IEC/EN 61000-4-2	Level 4
RS..... :IEC/EN 61000-4-3	Level 3
EFT..... :IEC/EN 61000-4-4	Level 4
SURGE..... :IEC/EN 61000-4-5	Level 4
CS..... :IEC/EN 61000-4-6	Level 3
Power-frequency Magnetic field..... :IEC/EN 61000-4-8	Level 4
Low Frequency Signals.....:IEC/EN 61000-2-2	
<b>Warning:</b> This is a product for commercial and industrial application in the second environment-installation restrictions or additional measures may be needed to prevent disturbances.	

## 2. Installation and Operation

There are two different types of online UPS: standard and long-run models. Please refer to the following model table.

Model	Type	Model	Type
10000	Standard model	10000L	Long-run model
15000		15000L	
20000		20000L	
30000		30000L	

We also offer optional parallel function for these two types by request. The UPS with parallel function is called as "Parallel model". We have described detailed installation and operation of Parallel Model in the following chapter.

### 2-1. Unpacking and Inspection

Unpack the package and check the package contents. The shipping package contains:

- One UPS
- One user manual
- One monitoring software CD
- One RS-232 cable (option)
- One USB cable
- One parallel cable (only available for parallel model)
- One share current cable (only available for parallel model)

**NOTE:** Before installation, please inspect the unit. Be sure that nothing inside the package is damaged during transportation. Do not turn on the unit and notify the carrier and dealer immediately if there is any damage or lacking of some parts. Please keep the original package in a safe place for future use.

2-2. Rear Panel View

EN

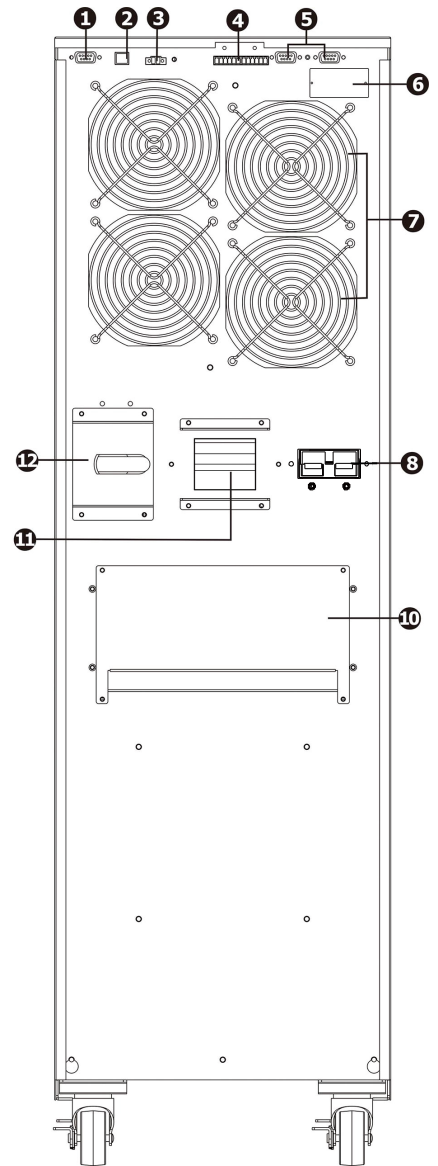
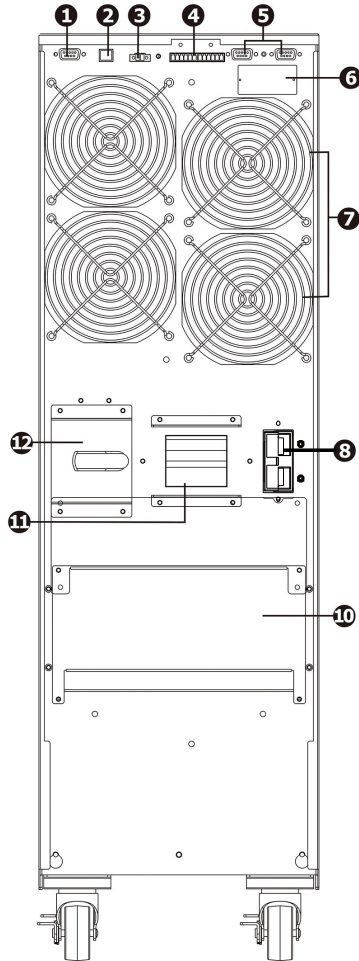
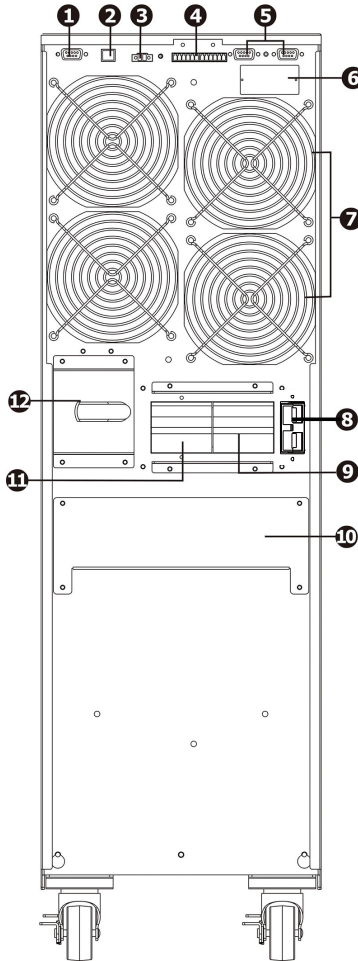

Diagram 1: 10000(L)/15000(L)  
/20000 (L)

Diagram 2: 30000L Rear Panel

Diagram 3: 30000 Rear Panel

Rear Panel

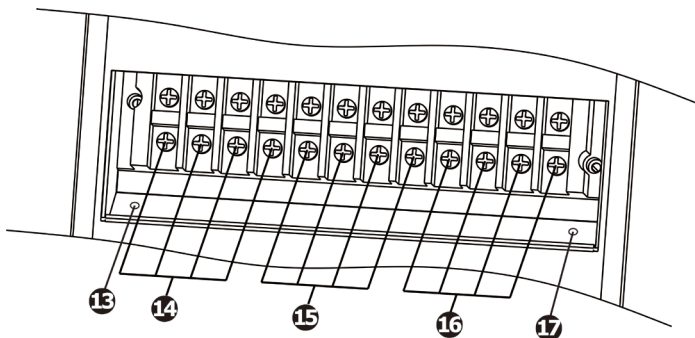

Diagram 3: 10000(L)15000(L)/20000(L)  
Input/Output Terminal

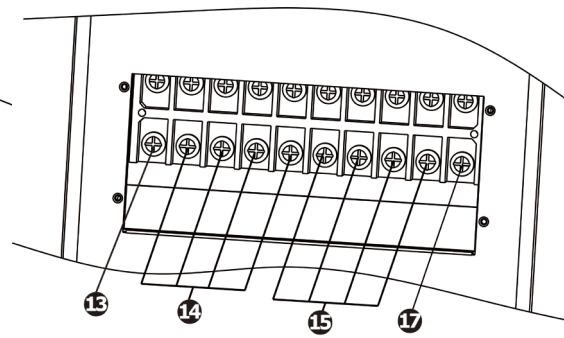

Diagram 4: 30000(L)  
Input/Output Terminal

1. RS-232 communication port
2. USB communication port
3. Emergency power off function connector (EPO connector)
4. Share current port (only available for parallel model)
5. Parallel port (only available for parallel model)
6. Intelligent slot
7. Power stage fan
8. External battery terminal
9. Bypass Input Circuit Breaker(Only available for dual input unit)
10. Input/Output terminal (Refer to Diagram 2)
11. Line Input circuit breaker
12. Maintenance bypass switch
13. Output Grounding terminal
14. Output terminal: connect to mission-critical loads
15. Line input terminal
16. Bypass input terminal(Only available for dual input)
17. Input Grounding terminal

### 2-3. Single UPS Installation

Installation and wiring must be performed in accordance with the local electric laws/regulations and execute the following instructions by professional personnel.

- 1) Make sure the mains wire and breakers in the building are enough for the rated capacity of UPS to avoid the hazards of electric shock or fire.

**NOTE:** Do not use the wall receptacle as the input power source for the UPS, as its rated current is less than the UPS's maximum input current. Otherwise the receptacle may be burned and destroyed.

- 2) Switch off the mains switch in the building before installation.
- 3) Turn off all the connected devices before connecting to the UPS.
- 4) Prepare wires based on the following table:

Model	Wiring spec (AWG)				
	Input(Ph)	Output(Ph)	Neutral	Battery	Ground
10000	10	10	8	/	8
10000L	10	10	8	8	8
15000	8	8	6	/	6
15000L	8	8	6	6	6
20000	8	8	6	/	6
20000L	8	8	6	6	6
30000	8	8	4	/	4
30000L	8	8	4	4	4

**NOTE 1:** The cable for 10000/10000L should be able to withstand over 40A current. It is recommended to use AWG 10 or thicker wire for Phase and AWG 8 or thicker wire for Neutral for safety and efficiency.

**NOTE 2:** The cable for 15000/15000L should be able to withstand over 63A current. It is recommended to use AWG 8 or thicker wire for Phase and AWG 6 or thicker wire for Neutral for safety and efficiency.

**NOTE 3:** The cable for 20000/20000L should be able to withstand over 63A current. It is recommended to use AWG 8 or thicker wire for Phase and AWG 6 or thicker wire for Neutral for safety and efficiency.

**NOTE 4:** The cable for 30000/30000L should be able to withstand over 63A current. It is recommended to use AWG 8 or thicker wire for Phase and AWG 4 or thicker wire for Neutral for safety and efficiency.

**NOTE 5:** The selections for color of wires should be followed by the local electrical laws and regulations.

5) Remove the terminal block cover on the rear panel of UPS. Then connect the wires according to the following terminal block diagrams: (Connect the earth wire first when making wire connection. Disconnect the earth wire last when making wire disconnection!)

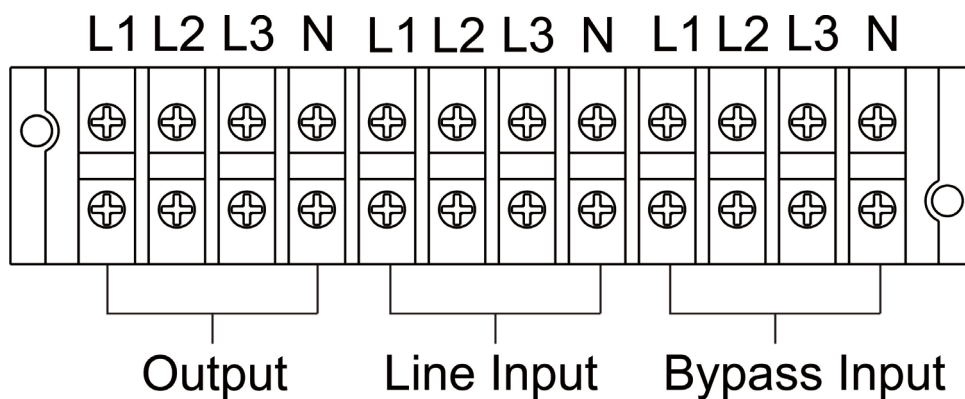

Terminal Block wiring diagram of 10000(L)/15000(L)/20000(L)

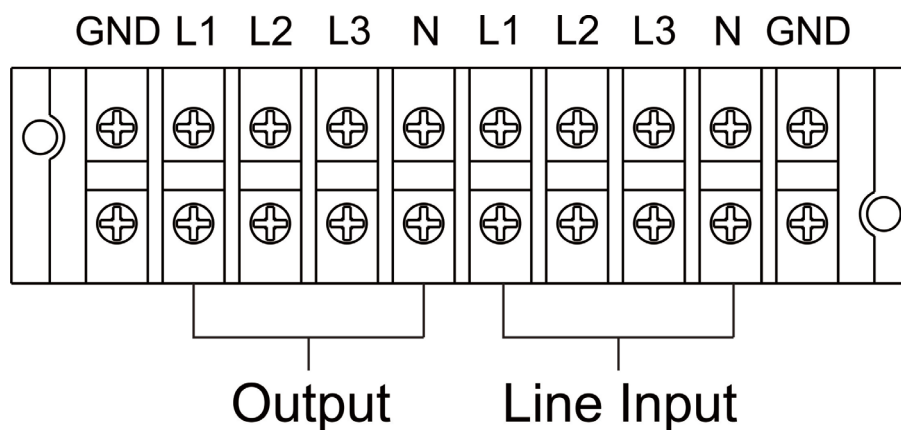

Terminal Block wiring diagram of 30000(L)



For dual input unit, if there is two separate input, connect the Line input and bypass input respectively; if the is only one common input, please connect the line input and bypass input together.

**NOTE 1:** Make sure that the wires are connected tightly with the terminals.

**NOTE 2:** Please install the output breaker between the output terminal and the load, and the breaker should be qualified with leakage current protective function if necessary.

6) Put the terminal block cover back to the rear panel of the UPS.



**Warning:** (Only for standard model)

- Make sure the UPS is not turned on before installation. The UPS should not be turned on during wiring connection.
- Do not try to modify the standard model to the long-run model. Particularly, do not try to connect the standard internal battery to the external battery. The battery type and voltage may be different. If you connect them together, it maybe causes the hazard of electric shock or fire!



**Warning:** (Only for long-run model)

- Make sure a DC breaker or other protection device between UPS and external battery pack is installed. If not, please install it carefully. Switch off the battery breaker before installation.

**NOTE:** Set the battery pack breaker in "OFF" position and then install the battery pack.

- Pay highly attention to the rated battery voltage marked on the rear panel. If you want to change the numbers of the battery pack, please make sure you modify the setting simultaneously. The connection with wrong battery voltage may cause permanent damage of the UPS. Make sure the voltage of the battery pack is correct.
- Pay highly attention to the polarity marking on external battery terminal block, and make sure the correct battery polarity is connected. Wrong connection may cause permanent damage of the UPS.
- Make sure the protective earth ground wiring is correct. The wire current spec, color, position, connection and conductance reliability should be checked carefully.
- Make sure the utility input & output wiring is correct. The wire current spec, color, position, connection and conductance reliability should be checked carefully. Make sure the L/N site is correct, not reverse and short-circuited.



## 2-4. UPS Installation for Parallel System

If the UPS is only available for single operation, you may skip this section to the next.

- 1) Install and wires the UPSs according to the section 2-3.
- 2) Connect the output wires of each UPS to an output breaker.
- 3) Connect all output breakers to a major output breaker. Then this major output breaker will directly connect to the loads.
- 4) Each UPS is connected to an independent battery pack.

**NOTE:** The parallel system can not use one battery pack. Otherwise, it will cause system permanent failure.

- 5) Refer to the following wiring diagram:

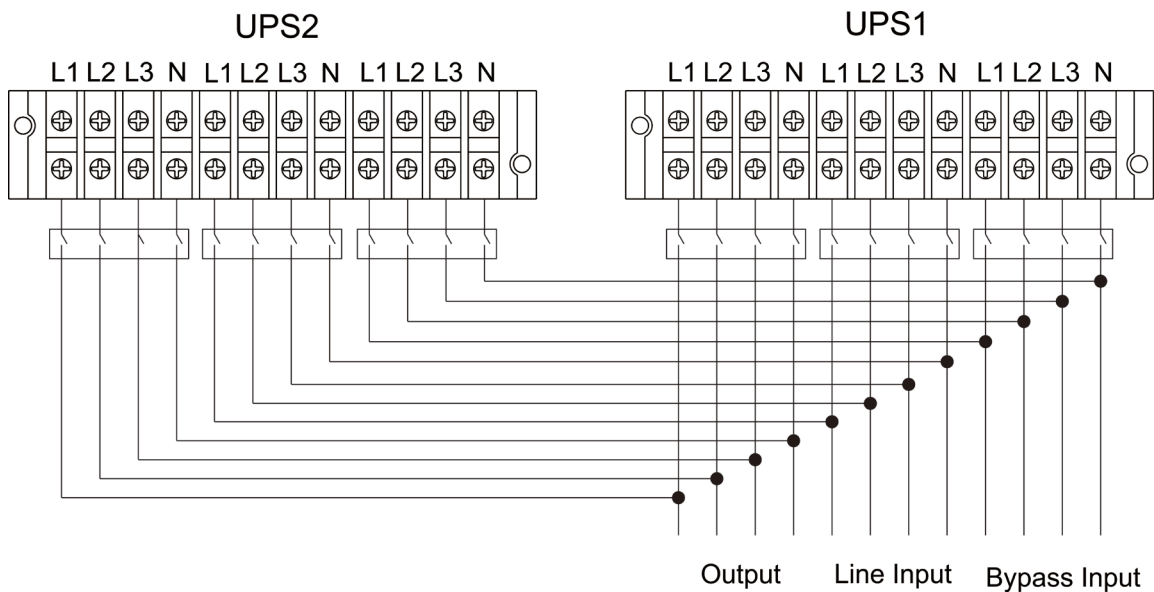

Wiring diagram of parallel system for 10000(L)/15000(L)/20000(L)

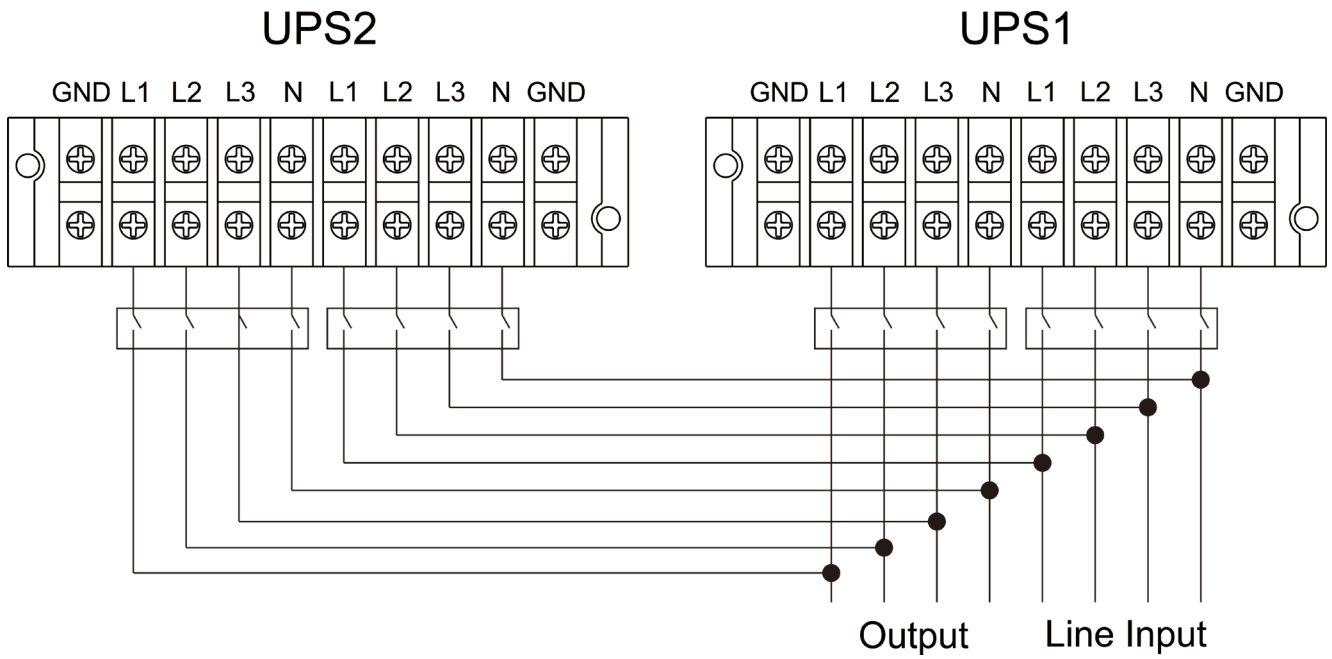

Wiring diagram of parallel system for 30000(L)

### 2-5. Software Installation

For optimal computer system protection, install UPS monitoring software to fully configure UPS shutdown.

### 3. Operations

#### 3-1. Button Operation

Button	Function
ON/Enter Button	<ul style="list-style-type: none"> <li>➤ Turn on the UPS: Press and hold the button more than 0.5s to turn on the UPS.</li> <li>➤ Enter Key: Press this button to confirm the selection in setting menu.</li> </ul>
OFF/ESC Button	<ul style="list-style-type: none"> <li>➤ Turn off the UPS: Press and hold the button more than 0.5s to turn off the UPS.</li> <li>➤ Esc key: Press this button to return to last menu in setting menu.</li> </ul>
Test/Up Button	<ul style="list-style-type: none"> <li>➤ Battery test: Press and hold the button more than 0.5s to test the battery while in AC mode and CVCF* mode.</li> <li>➤ UP key: Press this button to display next selection in setting menu.</li> </ul>
Mute/Down Button	<ul style="list-style-type: none"> <li>➤ Mute the alarm: Press and hold the button more than 0.5s to mute the buzzer. Please refer to section 3-4-9 for details.</li> <li>➤ Down key: Press this button to display previous selection in setting menu.</li> </ul>
Test/Up + Mute/Down Button	<ul style="list-style-type: none"> <li>➤ Press and hold the two buttons simultaneous more than 1s to enter/escape the setting menu.</li> </ul>

\* CVCF means Constant Voltage and Constant Frequency.

#### 3-2. LED Indicators and LCD Panel

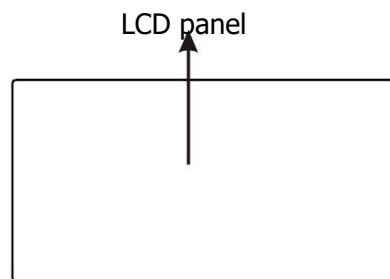

##### LED Indicators:

There are 4 LEDs on front panel to show the UPS working status:

Mode \ LED	Bypass	Line	Battery	Fault
UPS On	●	●	●	●
No Output mode	○	○	○	○
Bypass mode	●	○	○	○
AC mode	○	●	○	○
Battery mode	○	○	●	○
CVCF mode	○	●	○	○
Battery Test	●	●	●	○
ECO mode	●	●	○	○
Fault	○	○	○	●



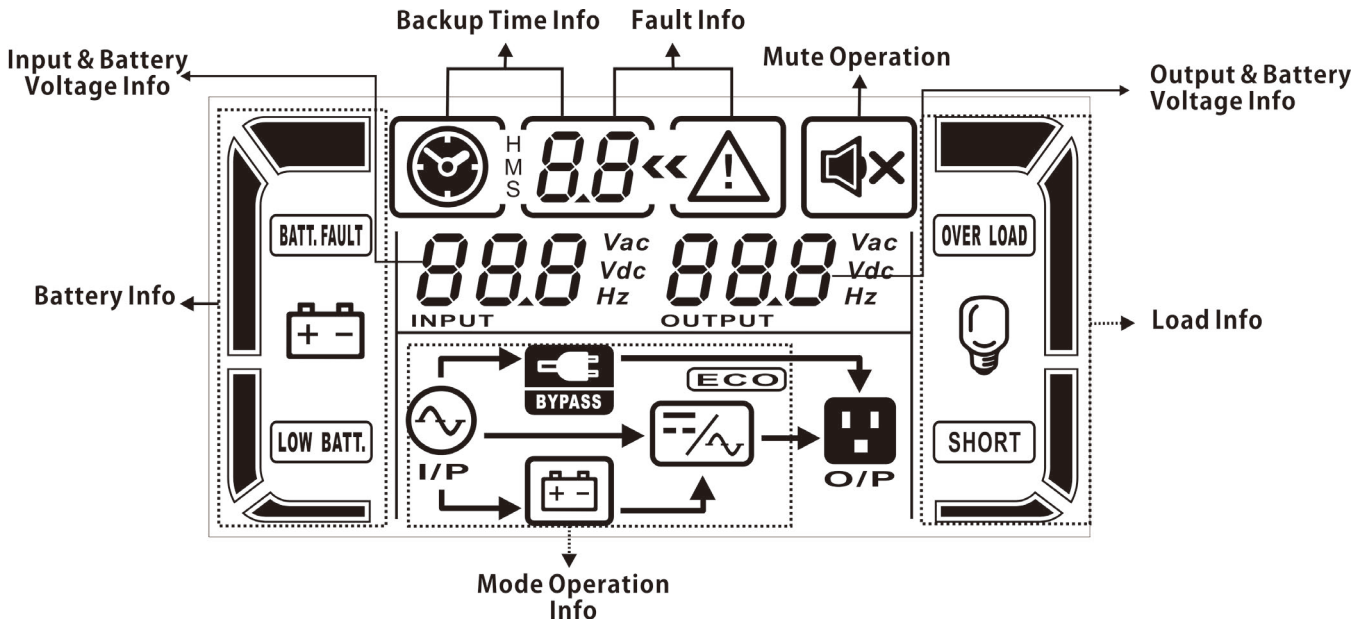

Note: ● means LED is lighting, and ○ means LED is faded.

**LCD Panel:**



Display	Function
<b>Backup time information</b>	
	Indicates the battery discharge time in numbers H: hours, M: minutes, S: seconds
<b>Fault information</b>	
	Indicates that the warning and fault occurs.
	Indicates the fault codes, and the codes are listed in details in section 3-9.
<b>Mute operation</b>	
	Indicates that the UPS alarm is disabled.
<b>Output &amp; Battery voltage information</b>	
	Indicates the output voltage, frequency or battery voltage. Vac: output voltage, Vdc: battery voltage, Hz: frequency
<b>Load information</b>	
	Indicates the load level by 0-25%, 26-50%, 51-75%, and 76-100%.
	Indicates overload.
	Indicates the load or the output is short.
<b>Mode operation information</b>	
	Indicates the UPS connects to the mains.
	Indicates the battery is working.
	Indicates the bypass circuit is working.
	Indicates the ECO mode is enabled.
	Indicates the Inverter circuit is working.
	Indicates the output is working.

EN

Battery information	
	Indicates the Battery capacity by 0-25%, 26-50%, 51-75%, and 76-100%.
	Indicates the battery is not connected.
	Indicates low battery level and low battery voltage.
Input & Battery voltage information	
	Indicates the input voltage or frequency or battery voltage. Vac: Input voltage, Vdc: battery voltage, Hz: input frequency

### 3-3. Audible Alarm

Description	Buzzer status	Muted
<b>UPS status</b>		
Bypass mode	Beeping once every 2 minutes	Yes
Battery mode	Beeping once every 4 seconds	
Fault mode	Beeping continuously	
<b>Warning</b>		
Overload	Beeping twice every second	No
Others	Beeping once every second	
<b>Fault</b>		
All	Beeping continuously	Yes

### 3-4. Single UPS Operation

#### 1. Turn on the UPS with utility power supply (in AC mode)

- 1) After power supply is connected correctly, set the breaker of the battery pack at "ON" position (the step only available for long-run model). Then set the line input breaker at "ON" position (for dual input unit, also set the bypass input breaker at "ON"). At this time the fan is running and the UPS enter to power on mode for initialization, several seconds later, UPS operates in Bypass mode and supplies power to the loads via the bypass.

**NOTE:** When UPS is in Bypass mode, the output voltage will directly power from utility after you switch on the input breaker. In Bypass mode, the load is not protected by UPS. To protect your precious devices, you should turn on the UPS. Refer to next step.

- 2) Press and hold the "ON" button for 0.5s to turn on the UPS and the buzzer will beep once.
- 3) A few seconds later, the UPS will enter to AC mode. If the utility power is abnormal, the UPS will operate in Battery mode without interruption.

**NOTE:** When the UPS is running out battery, it will shut down automatically at Battery mode. When the utility power is restored, the UPS will auto restart in AC mode.

#### 2. Turn on the UPS without utility power supply (in Battery mode)

- 1) Make sure that the breaker of the battery pack is at "ON" position (only for long-run model).
- 2) Press the "ON" button to set up the power supply for the UPS, UPS will enter to power on mode. After initialization UPS will enter to No Output mode, then Press and hold the "ON" button for 0.5s to turn on the UPS, and the buzzer will beep once.
- 3) A few seconds later, the UPS will be turned on and enter to Battery mode.

### 3. Connect devices to UPS

After the UPS is turned on, you can connect devices to the UPS.

- 1) Turn on the UPS first and then switch on the devices one by one, the LCD panel will display total load level.
- 2) If it is necessary to connect the inductive loads such as a printer, the in-rush current should be calculated carefully to see if it meets the capacity of the UPS, because the power consumption of this kind of loads is too big.
- 3) If the UPS is overload, the buzzer will beep twice every second.
- 4) When the UPS is overload, please remove some loads immediately. It is recommended to have the total loads connected to the UPS less than 80% of its nominal power capacity to prevent overload for system safety.
- 5) If the overload time is over acceptable time listed in spec at AC mode, the UPS will automatically transfer to Bypass mode. After the overload is removed, it will return to AC mode. If the overload time is over acceptable time listed in spec at Battery mode, the UPS will become fault status. At this time, if bypass is enabled, the UPS will power to the load via bypass. If bypass function is disabled or the input power is not within bypass acceptable range, it will cut off output directly.

### 4. Charge the batteries

- 1) After the UPS is connected to the utility power, the charger will charge the batteries automatically except in Battery mode or during battery self-test.
- 2) Suggest to charge batteries at least 10 hours before use. Otherwise, the backup time may be shorter than expected time.
- 3) Make sure the battery numbers setting on the control board (Please refer to the section 3-4-12 for detailed setting) is consistent to real connection.

### 5. Battery mode operation

- 1) When the UPS is in Battery mode, the buzzer will beep according to different battery capacity. If the battery capacity is more than 25%, the buzzer will beep once every 4 seconds; If the battery voltage drops to the alarm level, the buzzer will beep quickly (once every sec) to remind users that the battery is at low level and the UPS will shut down automatically soon. Users could switch off some non-critical loads to disable the shutdown alarm and prolong the backup time. If there is no more load to be switched off at that time, you have to shut down all loads as soon as possible to protect the devices or save data. Otherwise, there is a risk of data loss or load failure.
- 2) In Battery mode, if buzzer sound annoys, users can press the Mute button to disable the buzzer.
- 3) The backup time of the long-run model depends on the external battery capacity.
- 4) The backup time may vary from different environment temperature and load type.
- 5) When setting backup time for 16.5 hours (default value from LCD panel), after discharging 16.5 hours, UPS will shut down automatically to protect the battery. This battery discharge protection can be enabled or disabled through LCD panel control. (Refer to 3-7 LCD setting section)

### 6. Test the batteries

- 1) If you need to check the battery status when the UPS is running in AC mode/CVCF mode, you could press the "Test" button to let the UPS do battery self-test.
- 2) Users also can set battery self-test through monitoring software.

### 7. Turn off the UPS with utility power supply in AC mode

- 1) Turn off the inverter of the UPS by pressing "OFF" button for at least 0.5s, and then the buzzer will beep once. The UPS will turn into Bypass mode.

**NOTE 1:** If the UPS has been set to enable the bypass output, it will bypass voltage from utility power to output terminal even though you have turned off the UPS (inverter).

**NOTE 2:** After turning off the UPS, please be aware that the UPS is working at Bypass mode and there is risk of power loss for connected devices.

- 2) In Bypass mode, output voltage of the UPS is still present. In order to cut off the output, switch off the line input breaker(for dual input unit, also switch off the bypass line breaker). A few seconds later, there is no display shown on the display panel and UPS is complete off.

### 8. Turn off the UPS without utility power supply in Battery mode

- 1) Turn off the UPS by pressing "OFF" button for at least 0.5s, and then the buzzer will beep once.
- 2) Then UPS will cut off power to output and there is no display shown on the display panel.

### 9. Mute the buzzer

- 1) To mute the buzzer, please press the "Mute" button for at least 0.5s. If you press it again after the buzzer is muted, the buzzer will beep again.
- 2) Some warning alarms can't be muted unless the error is fixed. Please refer to section 3-3 for the details.

### 10. Operation in warning status

- 1) When Fault LED flashes and the buzzer beeps once every second, it means that there are some problems for UPS operation. Users can get the warning indicator from LCD panel. Please check the trouble shooting table in chapter 4 for details.
- 2) Some warning alarms can't be muted unless the error is fixed. Please refer to section 3-3 for the details.

### 11. Operation in Fault mode

- 1) When Fault LED illuminates and the buzzer beeps continuously, it means that there is a fatal error in the UPS. Users can get the fault code from display panel. Please check the trouble shooting table in chapter 4 for details.
- 2) Please check the loads, wiring, ventilation, utility, battery and so on after the fault occurs. Don't try to turn on the UPS again before solving the problems. If the problems can't be fixed, please contact the distributor or service people immediately.
- 3) For emergency case, please cut off the connection from utility, external battery, and output immediately to avoid more risk or danger.

### 12. Operation of changing battery numbers

- 1) This operation is only available for professional or qualified technicians.
- 2) Turn off the UPS. If the load couldn't be cut off, you should remove the cover of maintenance bypass switch on the rear panel and turn the maintenance switch to "BPS" position first.
- 3) Switch off the line input breaker(for dual input unit, also switch off the bypass input breaker), and switch off the battery breaker (only available for long-run model).
- 4) Remove the cabinet cover, and disconnect battery wire for standard model. Then modify the jumper of JS3 on the control board to set the battery numbers as following table.

Battery Number in series	JS3			
	pin1 & pin2	pin3 & pin4	Pin5 & pin6	pin7 & pin8
18	1	0	0	X
19	0	1	0	X
20	0	0	1	X

Note: 1 = connect with jumper; 0 = no jumper; x = the pins are for other functions.

- 5) Modify the battery pack for the setting number carefully. After complete it, put the cover back, switch on the battery breaker for long-run model.



- 6) Switch on the line input breaker (for dual input unit, also switch on the bypass input breaker) and the UPS will enter Bypass mode. If the UPS is in maintenance Bypass mode, turn the maintenance switch to "UPS" position and then turn on the UPS.

## 3-5. Parallel Operation

### 1. Parallel system initial startup

First of all, please make sure all of the UPSs are parallel models and have the same configuration.

- 1) Turn on each UPS to AC mode respectively (Refer to section 3-4(1)). Then, measure the inverter output voltage of each phase for each UPS to check if the inverter voltage difference between actual output and setting value is less than 1.5V (typical 1V) with multimeter. If the difference is more than 1.5V, please calibrate the voltage by configuring inverter voltage adjustment (Refer to Program 15, 16 and 17, section 3-7) in LCD setting. If voltage difference remains more than 1.5V after calibration, please contact your local distributor or service center for help.
- 2) Calibrate the output voltage measurement by configuring output voltage calibration (Refer to Program 18, 19, and 20, section 3-7) in LCD setting to make sure the difference between real output voltage and detected value of UPS is less than 1V.
- 3) Turn off each UPS (Refer to section 3-4(7.)). Then, follow the wiring procedure in section 2-4.
- 4) Remove the cover of parallel share current cable port on the UPS, connect each UPS one by one with the parallel cable and share current cable, and then screw the cover back.
- 5) **Turn on the parallel system in AC mode:**
  - a) Turn on the line input breaker of each UPS (for dual input, also turn on bypass input breaker). After all UPSs enter to bypass mode, measure the output voltage between two UPS for the same phase to make sure the phase sequence is correct. If these two voltage differences are near to zero, that means all connections are correct. Otherwise, please check if the wirings are connected correctly.
  - b) Turn on the output breaker of each UPS.
  - c) Turn on each UPS in turns. After a while, the UPSs will enter to AC mode synchronously and then, the parallel system is completed.
- 6) **Turn on the parallel system in Battery mode:**
  - a) Turn on the battery breaker (only available in long-run model) and output breaker of each UPS.  
**NOTE:** It's not allowed to share one battery pack for long-run UPSs in parallel system. Each UPS should be connected to its battery pack.
  - b) Turn on any UPS. A few seconds later, the UPS will enter to battery mode.
  - c) Then, turn on another UPS. A few seconds later, the UPS will enter to battery mode and add to the parallel system.
  - d) If you have the third UPS, follow the same procedure of c). Then, the parallel system is complete.

**If more detailed information is needed, please contact supplier or service center for parallel operation instruction.**

### 2. Add one new unit into the parallel system

- 1) You can not add one new unit into the parallel system when whole system is running. You must cut off the load and shutdown the system.
- 2) Make sure all of the UPS are the parallel models, and follow the wiring refer to section 2-4.
- 3) Install the new parallel system refers to the previous section.

### 3. Remove one unit from the parallel system

There are two methods to remove one unit from the parallel system:

First method:



- 1) Press the "OFF" key twice and each time should be lasted for more than 0.5s. Then, the UPS will enter into bypass mode or no output mode without output.
- 2) Turn off the output breaker of this unit, and then turn off the input breaker of this unit.
- 3) After it shuts down, you can turn off the battery breaker (for long-run model) and remove the parallel and share current cables. And then remove the unit from the parallel system.

Second method:

- 1) If the bypass is abnormal, you can not remove the UPS without interruption. You must cut off the load and shut down the system first.
- 2) Make sure the bypass setting is enabled in each UPS and then turn off the running system. All UPSs will transfer to Bypass mode. Remove all the maintenance bypass covers and set the maintenance switches from "UPS" to "BPS". Turn off all the input breakers and battery breakers in parallel system.
- 3) Turn off the output breaker and remove the parallel cable and share current cable of the UPS which you want to remove. Then, remove it from parallel system.
- 4) Turn on the input breaker of the remaining UPS and the system will transfer to Bypass mode. Set the maintenance switches from "BPS" to "UPS" and put the maintenance bypass covers back.
- 5) Turn on the remaining UPS according to the previous section.



**Warning:** (Only for the parallel system)

- Before turning on the parallel system to activate inverter, make sure that all unit's maintenance switch at the same position.
- When parallel system is turned on to work through inverter, please do not operate the maintenance switch of any unit.

### 3-6. Abbreviation Meaning in LCD Display

Abbreviation	Display content	Meaning
ENA	ENA	Enable
DIS	DIS	Disable
ATO	ATO	Auto
BAT	BAT	Battery
NCF	NCF	Normal mode (not CVCF mode)
CF	CF	CVCF mode
SUB	SUB	Subtract
ADD	ADD	Add
ON	ON	On
OFF	OFF	Off
FBD	FBD	Not allowed
OPN	OPN	Allow
RES	RES	Reserved
N.L	NL	Neutral line loss
CHE	CHE	Check

OP.V	OPV	Output voltage
PAR	PAR	Parallel, 001 means the first UPS
AN	AN	The first phase
BN	bN	The second phase
CN	CN	The third phase
AB	Ab	The first line
BC	bC	The second line
CA	cA	The third line

### 3-7. LCD Setting

There are three parameters to set up the UPS. Refer to following diagram.

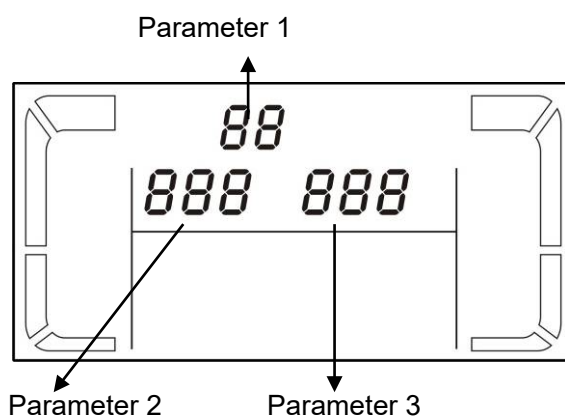

Parameter 1: It's for program alternatives. Refer to below tables for the programs to set up.

Parameter 2 and parameter 3 are the setting options or values for each program.

**Note:** Please select "Up" or "Down" button to change the programs or parameters.

#### Programs available list for parameter 1:

Code	Description	Bypass / No Output mode	AC mode	ECO mode	CVCF mode	Battery mode	Battery Test
01	Output voltage	Y*					
02	Output frequency	Y					
03	Voltage range for bypass	Y					
04	Frequency range for bypass	Y					
05	ECO mode enable/disable	Y					
06	Voltage range for ECO mode	Y					
07	Frequency range for ECO mode	Y					
08	Bypass mode setting	Y	Y				
09	Maximum battery discharge time setting	Y	Y	Y	Y	Y	Y
10	Reserved	Reserved for future options					
11	Reserved	Reserved for future options					
12	Neutral loss detection	Y	Y	Y	Y	Y	Y

13	Battery voltage calibration	Y	Y	Y	Y	Y	Y
14	Charger voltage adjustment	Y	Y	Y	Y	Y	Y
15	Inverter A voltage adjustment		Y		Y	Y	
16	Inverter B voltage adjustment		Y		Y	Y	
17	Inverter C voltage adjustment		Y		Y	Y	
18	Output A voltage calibration		Y		Y	Y	
19	Output B voltage calibration		Y		Y	Y	
20	Output C voltage calibration		Y		Y	Y	

\*Y means that this program can be set in this mode.

Note: All parameter settings will be saved only when UPS shuts down normally with internal or external battery connection. (Normal UPS shutdown means turning off input breaker in bypass/no output mode).

### ● 01: Output voltage

Interface	Setting
	<b>Parameter 3: Output voltage</b> You may choose the following output voltage in parameter 3: <b>208:</b> Presents output voltage is 208Vac <b>220:</b> Presents output voltage is 220Vac <b>230:</b> Presents output voltage is 230Vac <b>240:</b> Presents output voltage is 240Vac

### ● 02: Output frequency

Interface	Setting
<p><b>60 Hz, CVCF mode</b></p>	<b>Parameter 2: Output Frequency</b> Setting the output frequency. You may choose following three options in parameter 2: <b>50.0Hz:</b> The output frequency is setting for 50.0Hz. <b>60.0Hz:</b> The output frequency is setting for 60.0Hz. <b>ATO:</b> If selected, output frequency will be decided according to the latest normal utility frequency. If it is from 46Hz to 54Hz, the output frequency will be 50.0Hz. If it is from 56Hz to 64Hz, the output frequency will be 60.0Hz. ATO is default setting.
<p><b>50 Hz, Normal mode</b></p>	
<p><b>ATO</b></p>	
	<b>Parameter 3: Frequency mode</b> Setting output frequency at CVCF mode or not CVCF mode. You may choose following two options in parameter 3: <b>CF:</b> Setting UPS to CVCF mode. If selected, the output frequency will be fixed at 50Hz or 60Hz according to setting in parameter 2. The input frequency could be from 46Hz to 64Hz. <b>NCF:</b> Setting UPS to normal mode (not CVCF mode). If selected, the output frequency will synchronize with the input frequency within 46~54 Hz at 50Hz or within 56~64 Hz at 60Hz according to setting in parameter 2. If 50 Hz selected in parameter 2, UPS will transfer to battery mode when input frequency is not within 46~54 Hz. If 60Hz selected in parameter 2, UPS will transfer to battery mode when input frequency is not within 56~64 Hz. *If Parameter 2 is ATO, the Parameter 3 will show the current frequency.

**Note: For single unit, it will have bypass output for a couple of seconds after the unit is powered on. Therefore, to avoid damage on connected devices, it's strongly suggested to add an additional Output relay board for CVCF application.**

● **03: Voltage range for bypass**

Interface	Setting
	<p><b>Parameter 2:</b> Set the acceptable low voltage for bypass. Setting range is from 110V to 209V and the default value is 110V.</p> <p><b>Parameter 3:</b> Set the acceptable high voltage for bypass. Setting range is from 231V to 276V and the default value is 264V.</p>

● **04: Frequency range for bypass**

Interface	Setting
	<p><b>Parameter 2:</b> Set the acceptable low frequency for bypass. 50 Hz system: Setting range is from 46.0Hz to 49.0Hz. 60 Hz system: Setting range is from 56.0Hz to 59.0Hz. The default value is 46.0Hz/56.0Hz.</p> <p><b>Parameter 3:</b> Set the acceptable high frequency for bypass. 50 Hz: Setting range is from 51.0Hz to 54.0 Hz. 60 Hz: Setting range is from 61.0Hz to 64.0Hz. The default value is 54.0Hz/64.0Hz.</p>

● **05: ECO mode enable/disable**

Interface	Setting
	<p><b>Parameter 3:</b> Enable or disable ECO function. You may choose following two options: <b>DIS:</b> disable ECO function <b>ENA:</b> enable ECO function</p> <p>If ECO function is disabled, voltage range and frequency range for ECO mode still can be set, but it is meaningless unless the ECO function is enabled.</p>

● **06: Voltage range for ECO mode**

Interface	Setting
	<p><b>Parameter 2:</b> Low voltage point in ECO mode. The setting range is from -5% to -10% of the nominal voltage.</p> <p><b>Parameter 3:</b> High voltage point in ECO mode. The setting range is from +5% to +10% of the nominal voltage.</p>

● **07: Frequency range for ECO mode**

Interface	Setting
	<p><b>Parameter 2:</b> Set low voltage point for ECO mode. 50 Hz system: Setting range is from 46.0Hz to 48.0Hz. 60 Hz system: Setting range is from 56.0Hz to 58.0Hz. The default value is 48.0Hz/58.0Hz.</p> <p><b>Parameter 3:</b> Set high voltage point for ECO mode. 50 Hz: Setting range is from 52.0Hz to 54.0 Hz. 60 Hz: Setting range is from 62.0Hz to 64.0Hz. The default value is 52.0Hz/62.0Hz.</p>

● **08: Bypass mode setting**

Interface	Setting

	<p><b>Parameter 2:</b>  <b>OPN:</b> Bypass allowed. When selected, UPS will run at Bypass mode depending on bypass enabled/disabled setting.  <b>FBD:</b> Bypass not allowed. When selected, it's not allowed for running in Bypass mode under any situations.</p> <p><b>Parameter 3:</b>  <b>ENA:</b> Bypass enabled. When selected, Bypass mode is activated.  <b>DIS:</b> Bypass disabled. When selected, automatic bypass is acceptable, but manual bypass is not allowed. Manual bypass means users manually operate UPS for Bypass mode. For example, pressing OFF button in AC mode to turn into Bypass mode.</p>
--	--

● **09: Maximum battery discharge time setting**

Interface	Setting
	<p><b>Parameter 3:</b>  <b>000~999:</b> Set the maximum discharge time from 0 min to 999 min. UPS will shut down to protect battery if the discharge time arrives before the battery is under voltage. The default value is 990 min.  <b>DIS:</b> Disable battery discharge protection and backup time will depend on battery capacity.</p>

● **10: Reserved**

Interface	Setting
	<p>Reserve for future options.</p>

● **11: Reserved**

Interface	Setting
	<p>Reserve for future options.</p>

● **12: Neutral loss detection**

Interface	Setting
	<p><b>Parameter 2:</b>  <b>N.L:</b> Indicates neutral loss detection function.</p> <p><b>Parameter 3:</b>  <b>DIS:</b> Disable the neutral loss detection function. The UPS will not detect the neutral loss or not.  <b>ATO:</b> The UPS will automatically detect the neutral is lost or not. If neutral loss is detected, an alarm will be generated. If the UPS is turned on, it will transfer to battery mode. When neutral is restored and detected, the alarm will be muted automatically and the UPS will go back to normal mode automatically.</p>

	<p><b>CHE:</b> The UPS will automatically detect the neutral loss. If neutral loss is detected, an alarm will be generated. If the UPS is turned on, it will transfer to battery mode. When neutral is restored, the alarm will NOT be muted automatically and the UPS will NOT go back to normal mode automatically.</p> <p>Here, you must mute the alarm and make the UPS go back to normal mode manually. The operation is: Firstly, enter this menu and press the "Enter" key to make the "CHE" flash. Secondly, press the "Enter" key again to activate the neutral detection (check). If neutral is detected, the alarm will be muted and the UPS will go back to normal mode. If neutral is not detected, the UPS will continue alarming and stay on the latest status until the neutral is detected well at next manual checking operation.</p> <p>CHE is default setting.</p>
--	--

● **13: Battery voltage calibration**

Interface	Setting
	<p><b>Parameter 2:</b> Select "Add" or "Sub" function to adjust battery voltage to real figure.</p> <p><b>Parameter 3:</b> the voltage range is from 0V to 9.9V and the default value is 0V.</p>

● **14: Charger voltage adjustment**

Interface	Setting
	<p><b>Parameter 2:</b> you may choose <b>Add</b> or <b>Sub</b> to adjust charger voltage</p> <p><b>Parameter 3:</b> the voltage range is from 0V to 9.9V and the default value is 0V.</p> <p><b>NOTE:</b></p> <p>*Before making voltage adjustment, be sure to disconnect all batteries first to get the accurate charger voltage.</p> <p>* Any modification should be suitable to battery specifications.</p>

● **15: Inverter A voltage adjustment**

Interface	Setting
	<p><b>Parameter 2:</b> you may choose <b>Add</b> or <b>Sub</b> to adjust inverter A voltage.</p> <p><b>Parameter 3:</b> the voltage range is from 0V to 9.9V and the default value is 0V.</p>

● **16: Inverter B voltage adjustment**

Interface	Setting
	<p><b>Parameter 2:</b> you may choose <b>Add</b> or <b>Sub</b> to adjust inverter B voltage*.</p> <p><b>Parameter 3:</b> the voltage range is from 0V to 9.9V and the default value is 0V.</p> <p>*It will display number 1 under <i>Add</i> or <i>Sub</i> to represent inverter B voltage.</p>

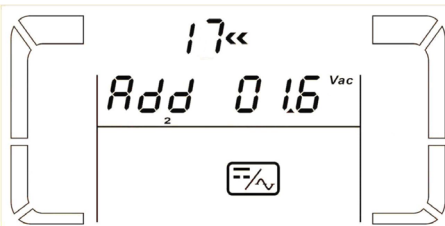

● **17: Inverter C voltage adjustment**

Interface	Setting
	<p><b>Parameter 2:</b> you may choose <b>Add</b> or <b>Sub</b> to adjust inverter C voltage*.</p> <p><b>Parameter 3:</b> the voltage range is from 0V to 9.9V, the default value is 0V.</p> <p>*It will display number 2 under <i>Add</i> or <i>Sub</i> to represent inverter C voltage.</p>

● **18: Output A voltage calibration**

Interface	Setting
	<p><b>Parameter 2:</b> it always shows <b>OP.V</b> as output voltage.</p> <p><b>Parameter 3:</b> it shows the internal measurement value of the output A voltage, and you can calibrate it by pressing <b>Up</b> or <b>Down</b> according to the measurement from an external voltage meter. The calibration result will be effective by pressing <b>Enter</b>. The calibration range is limited within +/-9V. This function is normally used for parallel operation.</p>

● **19: Output B voltage calibration**

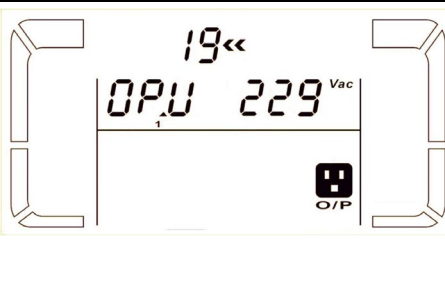
Interface	Setting
	<p><b>Parameter 2:</b> it always shows <b>OP.V</b> as output voltage*.</p> <p><b>Parameter 3:</b> it shows the internal measurement value of the output B voltage, and you can calibrate it by pressing <b>Up</b> or <b>Down</b> according to the measurement from an external voltage meter. The calibration result will be effective by pressing <b>Enter</b>. The calibration range is limited within +/-9V. This function is normally used for parallel operation.</p> <p>*It will display number 1 under <i>OPV</i> to represent the output B voltage.</p>

● **20: Output C voltage calibration**

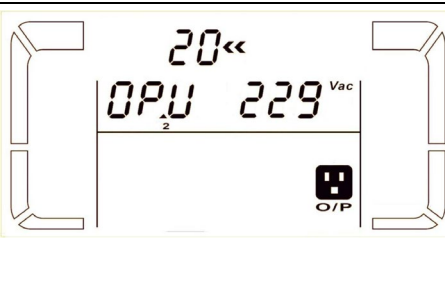
Interface	Setting
	<p><b>Parameter 2:</b> it always shows <b>OP.V</b> as output voltage.</p> <p><b>Parameter 3:</b> it shows the internal measurement value of the output C voltage, and you can calibrate it by pressing <b>Up</b> or <b>Down</b> according to the measurement from an external voltage meter. The calibration result will be effective by pressing <b>Enter</b>. The calibration range is limited within +/-9V. This function is normally used for parallel operation.</p> <p>*It will display number 2 under <i>OPV</i> to represent the output C voltage.</p>

### 3-8. Operating Mode/Status Description

Following table shows LCD display for operating modes and status.

(1) If the UPS is in normal operation, it will show seven screens one by one, which represents 3 phase input voltages (An, bn, Cn), 3 line input voltages (Ab, bC, CA) and frequency in turns.

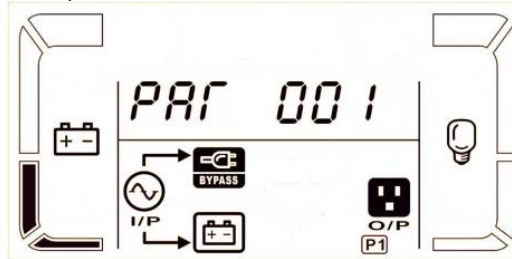

(2) If parallel UPS systems are successfully set up, it will show one more screen with "PAR" in parameter 2 and assigned number in parameter 3 as below parallel screen diagram. The master UPS will be default assigned as "001" and slave UPSs will be assigned as either "002" or "003". The assigned numbers may be changed dynamically in the operation;



Parallel screen

Operating mode/status		
UPS Power On	Description	When UPS is powered on, it will enter into this mode for a few seconds as initializing the CPU and system.
	LCD display	
No-output mode	description	When bypass voltage/frequency is out of acceptable range or bypass is disabled (or forbidden), UPS will enter into no-output mode if powering on or turning off the UPS. It means the UPS has no output. Alarm beeps every two minutes.
	LCD display	

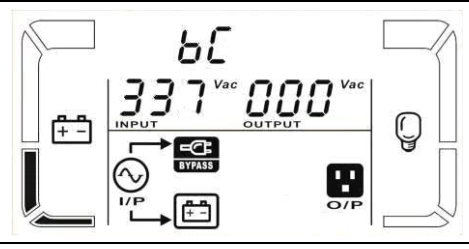
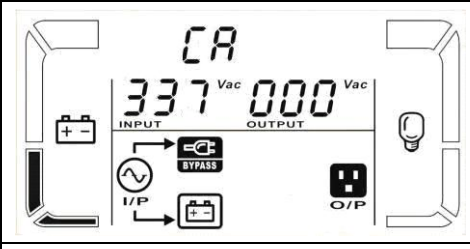
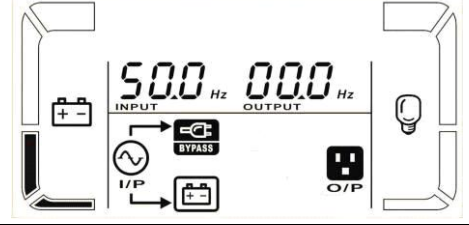
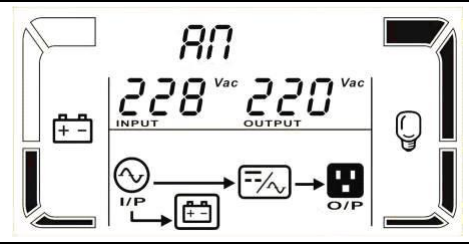
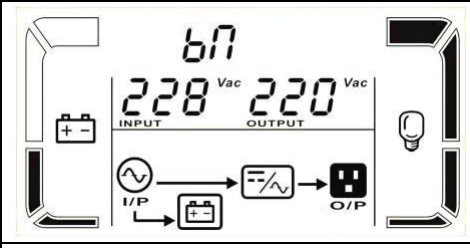
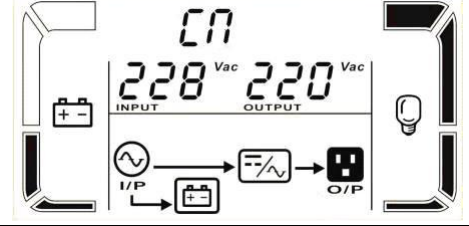
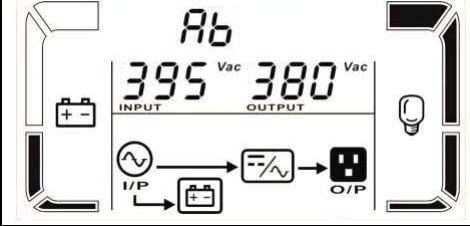
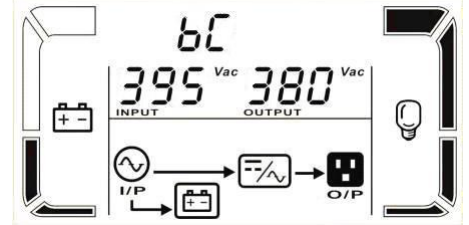
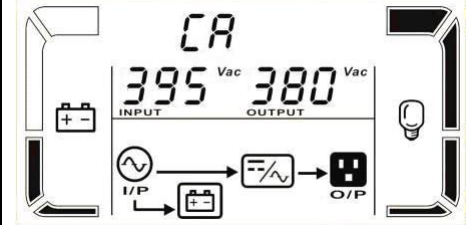
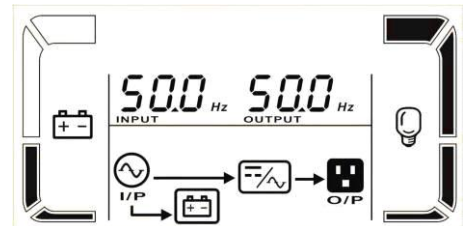



			
			
AC mode	Description	When the input voltage is within acceptable range, UPS will provide pure and stable AC power to output. The UPS will also charge the battery at AC mode.	
	LCD display		
			
			
			
ECO mode	Description	When the input voltage is within voltage regulation range and ECO mode is enabled, UPS will bypass voltage to output for energy saving.	
	LCD display		

<p>CVCF mode</p>	<p>Description</p>	<p>When the output frequency is set to "CF", the inverter will output constant frequency (50 Hz or 60 Hz). At this mode, the UPS will have no bypass output but still charge battery.</p>	
	<p>LCD display</p>		

Battery mode	Description	When the input voltage/frequency is beyond the acceptable range or power failure, UPS will backup power from battery and alarm will beep every 4 seconds.	
	LCD display		
Bypass mode	Description	When input voltage is within acceptable range and bypass is enabled, turn off the UPS and it will enter Bypass mode. Alarm beeps every two minutes.	
	LCD display		

<p>Battery Test</p>	<p>Description</p>	<p>When UPS is in AC mode or CVCF mode, press "Test" key for more than 0.5s. Then, the UPS will beep once and start "Battery Test". The line between I/P and inverter icons will blink to remind users. This operation is used to check the battery status.</p>	
	<p>LCD display</p>		
<p>Warning status</p>	<p>Description</p>	<p>If some errors occur in the UPS (but it is still running normally), it will show one more screen to represent the warning situation. In the warning screen, the icon  will be flashing, and it can show up to 3 error codes and each code indicates one error. You can find the code meaning in the warning code table.</p>	
	<p>LCD display</p>		

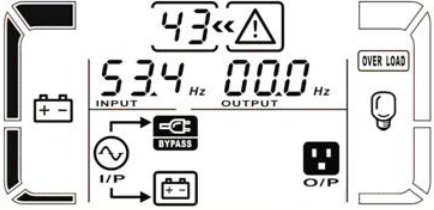
Fault status	Description	When UPS has fault happened, the inverter will be blocked. It will display fault code in screen, and the icon  will light up. You can find the code meaning in the fault code table.	
LCD display			
			

EN



### 3-9. Fault Code

Fault code	Fault event	Icon	Fault code	Fault event	Icon
01	Bus start failure	None	1A	Inverter A negative power fault	None
02	Bus over	None	1B	Inverter B negative power fault	None
03	Bus under	None	1C	Inverter C negative power fault	None
04	Bus unbalance	None	21	Battery SCR short circuited	None
06	Converter over current	None	24	Inverter relay short circuited	None
11	Inverter soft start failure	None	29	Battery fuse broken in Battery mode	None
12	High inverter voltage	None	31	Parallel communication failure	None
13	Low inverter voltage	None	36	Parallel output current unbalance	None
14	Inverter A output(line to neutral) short circuited		41	Over temperature	None
15	Inverter B output(line to neutral) short circuited		42	DSP communication failure	None
16	Inverter C output(line to neutral) short circuited		43	Overload	
17	Inverter A-B output (line to line) short circuited		46	Incorrect UPS setting	None
18	Inverter B-C output (line to line) short circuited		47	MCU communication failure	None
19	Inverter C-A output (line to line) short circuited		48	Two DSP firmware versions are incompatible.	None
			49	Input and output phases are incompatible	None

### 3-10.Warning Indicator

Warning	Icon (flashing)	Alarm
Battery low		Beeping every second
Overload		Beeping twice every second
Battery unconnected		Beeping every second
Over charge		Beeping every second
EPO enable		Beeping every second
Fan failure/Over temperature		Beeping every second
Charger failure		Beeping every second
I/P fuse broken		Beeping every second
Overload 3 times in 30min		Beeping every second



### 3-11.Warning Code



Warning code	Warning event	Warning code	Warning event
01	Battery unconnected	10	L1 IP fuse broken*
02	IP Neutral loss	11	L2 IP fuse broken*
04	IP phase abnormal	12	L3 IP fuse broken*
05	Bypass phase abnormal	21	Line situations are different in parallel system
07	Over charge	22	Bypass situations are different in parallel system
08	Low battery	33	Locked in bypass after overload 3 times in 30 minutes
09	Overload	34	Converter current unbalance
0A	Fan failure	35	Battery fuse broken
0B	EPO enable	3A	Cover of maintain switch is open
0D	Over temperature	3C	Utility extremely unbalanced
0E	Charger failure	3D	Bypass unstable

\* These alarms are only for the single input unit.

## 4. Trouble Shooting

If the UPS system does not operate correctly, please solve the problem by using the table below.

Symptom	Possible cause	Remedy
No indication and alarm in the front display panel even though the mains is normal.	The AC input power is not connected well.	Check if input cable firmly connected to the mains.
The icon  and the warning code <b>EP</b> flash on LCD display and alarm beeps every second.	EPO function is activated. At this time, the EPO switch is in "OFF" status or the jumper is open.	Set the circuit in closed position to disable the EPO function.
The icon  and <b>BATT. FAULT</b> flash on LCD display and alarm beeps every second.	The external or internal battery is incorrectly connected.	Check if all batteries are connected well.
The icon  and <b>OVER LOAD</b> flash on LCD display and alarm beeps twice every second.	UPS is overload.	Remove excess loads from UPS output.
	UPS is overloaded. Devices connected to the UPS are fed directly by the electrical network via the Bypass.	Remove excess loads from UPS output.
	After repetitive overloads, the UPS is locked in the Bypass mode. Connected devices are fed directly by the mains.	Remove excess loads from UPS output first. Then shut down the UPS and restart it.
Fault code is shown as 43. The icon <b>OVER LOAD</b> lights on LCD display and alarm beeps continuously.	UPS is overload too long and becomes fault. Then UPS shut down automatically.	Remove excess loads from UPS output and restart it.
Fault code is shown as 14, the icon <b>SHORT</b> lights on LCD display, and alarm beeps continuously.	The UPS shut down automatically because short circuit occurs on the UPS output.	Check output wiring and if connected devices are in short circuit status.

Other fault codes are shown on LCD display and alarm beeps continuously.	A UPS internal fault has occurred.	Contact your dealer
Battery backup time is shorter than nominal value	Batteries are not fully charged	Charge the batteries for at least 7 hours and then check capacity. If the problem still persists, consult your dealer.
	Batteries defect	Contact your dealer to replace the battery.
The icon  and  flash on LCD display and alarm beeps every second.	Fan is locked or not working; or the UPS temperature is too high.	Check fans and notify dealer.
<b>Symptom</b>	<b>Possible cause</b>	<b>Remedy</b>
The warning code 02 is shown, the icon  flashes on LCD display, and alarm beeps every second.	The input neutral wire is disconnected.	Check and correct the input neutral connection. If the connection is ok and the alarm is still displaying, please refer to the LCD setting section, to enter the neutral loss check menu, to see if the parameter3 is "CHE", if it is, please press the "Enter" key firstly to make the "CHE" flash and press the "Enter" key secondly to make the UPS clear the alarm. If the warning still exists, please check input fuses of L2 and L3.
	The L2 or L3 input fuse is broken.	Replace the fuse.



## 5. Storage and Maintenance

### 5-1. Storage

Before storing, charge the UPS at least 7 hours. Store the UPS covered and upright in a cool, dry location. During storage, recharge the battery in accordance with the following table:

Storage Temperature	Recharge Frequency	Charging Duration
-25°C - 40°C	Every 3 months	1-2 hours
40°C - 45°C	Every 2 months	1-2 hours

### 5-2. Maintenance

 The UPS system operates with hazardous voltages. Repairs may be carried out only by qualified maintenance personnel.

 Even after the unit is disconnected from the mains, components inside the UPS system are still connected to the battery packs which are potentially dangerous.

 Before carrying out any kind of service and/or maintenance, disconnect the batteries and verify that no current is present and no hazardous voltage exists in the terminals of high capability capacitor such as BUS-capacitors.

 Only persons are adequately familiar with batteries and with the required precautionary measures may replace batteries and supervise operations. Unauthorized persons must be kept well away from the batteries.

 Verify that no voltage between the battery terminals and the ground is present before maintenance or repair. In this product, the battery circuit is not isolated from the input voltage. Hazardous voltages may occur between the battery terminals and the ground.

 Batteries may cause electric shock and have a high short-circuit current. Please remove all wristwatches, rings and other metal personal objects before maintenance or repair, and only use tools with insulated grips and handles for maintaining or repairing.

 When replace the batteries, install the same number and same type of batteries.

 Do not attempt to dispose of batteries by burning them. This could cause battery explosion. The batteries must be rightly deposed according to local regulation.

 Do not open or destroy batteries. Escaping electrolyte can cause injury to the skin and eyes. It may be toxic.

 Please replace the fuse only with the same type and amperage in order to avoid fire hazards.

 Do not disassemble the UPS system.

## 6. Specifications

MODEL		10000	10000L	15000	15000L	20000	20000L	30000	30000L
<b>CAPACITY*</b>		10000VA / 9000W		15000VA / 13500W		20000VA / 18000W		30000VA / 27000W	
<b>INPUT</b>									
Voltage Range	Low Line Loss	110 VAC(Ph-N) $\pm$ 3 % at 50% Load 176 VAC(Ph-N) $\pm$ 3 % at 100% Load							
	Low Line Comeback	Low Line Loss Voltage + 10V							
	High Line Loss	300 VAC(L-N) $\pm$ 3 % at 50% Load 276 VAC(L-N) $\pm$ 3 % at 100% Load							
	High Line Comeback	High Line Loss Voltage - 10V							
Frequency Range		46Hz ~ 54 Hz @ 50Hz system 56Hz ~ 64 Hz @ 60Hz system							
Phase		Three phase with Neutral							
Power Factor		$\geq$ 0.99 at 100% Load							
<b>OUTPUT</b>									
Phase		Three Phase with Neutral							
Output voltage		208/220/230/240VAC(Ph-N)							
AC Voltage Regulation		$\pm$ 1%							
Frequency Range (Synchronized Range)		46Hz ~ 54 Hz @ 50Hz system 56Hz ~ 64 Hz @ 60Hz system							
Frequency Range (Batt. Mode)		50 Hz $\pm$ 0.1 Hz or 60Hz $\pm$ 0.1 Hz							
Overload	AC mode	100%~110%: 10min 110%~130%: 1min >130% : 1sec							
	Battery mode	100%~110%: 30sec 110%~130%: 10sec >130% : 1sec							
Current Crest Ratio		3:1 max							
Harmonic Distortion		$\leq$ 2 % @ 100% Linear Load; $\leq$ 5 % @ 100% Non-linear Load							
Transfer Time	Line $\longleftrightarrow$ Battery	0 ms							
	Inverter $\longleftrightarrow$ Bypass	0 ms (When phase lock fails, <4ms interruption occurs from inverter to bypass)							
	Inverter $\longleftrightarrow$ ECO	<10 ms							
<b>EFFICIENCY</b>									
AC mode		> 89%	> 89%	> 89%	> 89%	> 89%	> 89%	> 89%	> 90%
Battery Mode		> 86%	> 88%	> 88%	> 88%	> 87%	> 87%	> 87%	> 89%
<b>BATTERY</b>									
Standard Model	Type	12 V / 9 Ah		12 V / 9 Ah		12 V / 9 Ah		12 V / 9 Ah	
	Numbers	20(18-20 adjustable)		2 x 20(18-20 adjustable)		2 x 20(18-20 adjustable)		3 x 20(18-20 adjustable)	
	Recharge Time	9 hours recover to 90% capacity							
	Charging Current	1.0 A $\pm$ 10% (max.)		2.0 A $\pm$ 10% (max.)		2.0 A $\pm$ 10% (max.)		4.0 A $\pm$ 10% (max.)	
	Charging Voltage	273 VDC $\pm$ 1%							
Long-run Model	Type	Depending on applications							
	Numbers	18 - 20							
	Charging Current	4.0 A $\pm$ 10% (max.)		4.0 A $\pm$ 10% (max.)		4.0 A $\pm$ 10% (max.)		12.0 A $\pm$ 10% (max.)	
	Charging Voltage	273 VDC $\pm$ 1%							
<b>PHYSICAL</b>									
Outline	Dimension, D X W X H mm	815X250 X826	592X250 X826	815X250 X826	592X250 X826	815X250 X826	592X250 X826	815 X 300 X 1000	815X250 X 826
	Net Weight (kgs)	109	38	164	40	164	40	233.5	64
Packaging	Dimension, D X W X H mm	920X380 X1025	700X385 X1071	920X380 X1025	700X385 X1071	920X380 X1025	700X385 X1071	920 X 430 X 1205	920X380 X 1025
	Net Weight (kgs)	127	45	182	47	182	47	250.5	90
<b>ENVIRONMENT</b>									
Operation Temperature		0 ~ 40°C (the battery life will down when > 25°C)							
Operation Humidity		<95 % and non-condensing							
Operation Altitude**		<1000m							
Acoustic Noise Level		Less than 60dB @ 1 Meter			Less than 65dB @ 1 Meter				
<b>MANAGEMENT</b>									
Smart RS-232 or USB		Supports Windows® 2000/2003/XP/Vista/2008, Windows® 7, Linux, Unix, and MAC							
Optional SNMP		Power management from SNMP manager and web browser							

\* Derate capacity to 90% when the output voltage is adjusted to 208VAC.

\*\*If the UPS is installed or used in a place where the altitude is above than 1000m, the output power must be derated one percent per 100m.

\*\*\*Product specifications are subject to change without further notice.